

窗 / WINDOWS

窗 / WINDOWS

门 / DOORS

幕墙 / CURTAIN

阳光房 / SUN ROOM

护栏 / GUARDRAIL

遮阳 / SUNSHADE

将创新的理念融入设计，实现建筑的节能、环保，
塑造可持续发展的人居生活环境。

Integrate innovative ideas into the design to realize energy
conservation and environmental protection of buildings,
To create a sustainable living environment.



曜石黑



金属咖啡



金属灰



黑金沙



景不一样 家才不一样

家
是所有路的起点
也是一个心得终结
是万水千山后
回头依然走不出的那抹炊烟
是珍贵的财宝，你无法带走
是最沉重的行囊，你不能放下
是一份风筝的牵挂
是买好归票之前的出发
是万里归途的港湾
是相聚时温暖的笑语



采购大品牌匹配配件
 优质五金拉手，氧化表面处理
 整体精工组装成型
 经久耐用，高强度，耐腐蚀
 超十万次机械传动寿命

PRODUCT FUNCTION

| 高强度、轻质

铝合金材料空芯薄壁组合断面，方便使用减轻重量，且截面具有较高的抗弯强度。

| 高质量型材设计

在型材方面，各种密封条固定凹槽，和断面在挤压成型过程中一同完成。

| 框扇宽幅大

可实现镶装大面积高强度玻璃，让室内光线充足明亮，让居室更富有明暗层次。

| 密封性能优良

选用高品质橡胶密封胶条，充分实现高水密性、隔音性、气密性。

| 耐腐蚀性能优良

铝合金氧化层经过表面处理，消光电泳，喷涂、木纹等，不褪色，不脱落，高耐候性能。

| 设计造型美观现代

时尚环保，高端品质，配合一体化系统配件，实现开启随意。

- 08 ALUMINUM PLATE VENTILATION WINDOW
铝板通风窗
- 10 L70-IW / OW INSIDE & OUTSIDE CASEMENT WINDOW
内开 / 外开窗
- 12 L70-ID / OD INSIDE & OUTSIDE CASEMENT DOOR
内开 / 外开门
- 14 L80-IW / OW INSIDE & OUTSIDE CASEMENT WINDOW
内开 / 外开窗
- 16 L80-IW INSIDE & OUTSIDE CASEMENT WINDOW
双内开窗
- 18 L80-ID / OD INSIDE & OUTSIDE CASEMENT DOOR
内开 / 外开门
- 20 L90-OW OUTSIDE CASEMENT WINDOW WITH HIDDEN YARN
隐纱外开窗
- 22 116-OW OUTSIDE CASEMENT WINDOW WITH HIDDEN YARN
外开窗纱一体窗
- 24 L127-IW / OW OPEN INSIDE / OUTSIDE CASEMENT WINDOW
内/外开窗纱一体窗
- 26 L136-LD DOUBLE TRACK LIFTING SLIDING DOOR
双轨提升推拉门
- 28 L204-LD THREE RAIL LIFTING SLIDING DOOR
三轨提升推拉门（带金刚网）
- 30 L120-NSD MEDIUM NARROW SLIDING DOOR
中窄推拉门
- 32 L185-NSD MEDIUM NARROW SLIDING DOOR
中窄推拉门
- 34 DOUBLE RAIL TRACK SLIDING WINDOW
双轨推拉窗
- 35 THREE RAIL TRACK SLIDING WINDOW
三轨推拉窗（金刚网）
- 36 EXTERNAL HANGING HIGH POROSITY/BUDDHA'S WARRIOR
ATTENDANT TSCREEN WINDOW
外挂高透网 / 外挂金刚网
- 37 U-SHAPED HOLLOW / SOLID GLASS GUARDRAIL
U型空心 / 实心款护栏

景不一样 家才不一样



SIGHT 6

无边泳池

无边泳池，让视野无限延伸，让心灵自由驰骋。在清晨的第一缕阳光中醒来，在傍晚的最后一抹余晖中入睡，感受大自然的呼吸，感受生活的真谛。

无边泳池，让视野无限延伸，让心灵自由驰骋。在清晨的第一缕阳光中醒来，在傍晚的最后一抹余晖中入睡，感受大自然的呼吸，感受生活的真谛。



SIGHT 7

ALUMINUM PLATE VENTILATION WINDOW

大视野·畅通风

微通风，MAX超大景观畅通风

铝板通风窗

窗型特点 / PRODUCT FEATURES

- 大视野，大玻璃阳光充裕、风格简约时尚
- 两测182毫米定制铝板开启扇，实现平开扇通风，标配欧洲高端五金配件，轻松开合
- 中空超白钢化玻璃，可选配内置手动磁控百叶、电动百叶
- 隔热断桥型材，三腔结构强度高，隔音好
- 先进表面处理工艺，整体门窗结构更牢固、耐用





产品性能 / PERFORMANCE

-  型材壁厚
2.0mm
-  型材处理
消光电泳/喷涂/木纹等
-  胶条类型
EPDM软硬共挤胶条
-  隔热条
24宽
-  五金承重
最高60Kg
-  玻璃规格
6G+12A+6G / 5G+15A+5G
5G+9A+5G+9A+5G
-  扇宽度适用范围 /182mm
扇高度适用范围 /800mm-3000mm
-  五金配件
内开: 无底座执手+标准内开配置+隐藏铰链

 保温性能 / Thermal insulation
W/(m²·K): **1.8**

 隔音性能 / Acoustic Performance
(dB): **3级**

 气密性能 / Air tightness
(m³/h): **8级**

 水密性能 / Water Tightness
(Pa): **6级**

 抗风压性能 / Wind Load Resistance
(kpa): **9级**



曜石黑



金属咖啡



金属灰



黑金沙

SIGHT 8



SIGHT 9

L70-IW / OW

INSIDE & OUTSIDE CASEMENT WINDOW

内开 / 外开窗

窗型特点 / PRODUCT FEATURES

- 隔热断桥型材，保温节能；三腔结构，强度高、隔音好。型材设计采用欧洲标准五金槽口，多个锁点，达到更好的防盗作用。
- 采用进口粉末喷涂、进口消光漆、氟碳喷涂。
- 标配欧洲高端五金配件，轻松开闭，安全可靠。
- 外框和内扇之间等压、减压原理设计，采用欧标三元乙丙（EPDM）密封胶条，使隔音、隔热、防水、气密性能更佳。
- 中空超白钢化玻璃，也可选配内置手动磁控百叶、电动百叶。
- 内平开、内倒（可带纱网）、外开。
- 别墅、自建别墅、高档小区、办公楼、酒店、豪华公寓等中高端消费群体。



曜石黑



金属咖啡



金属灰



黑金沙

SIGHT 10

产品性能 / PERFORMANCE

-  型材壁厚 1.8mm
-  型材处理 消光电泳/喷涂等
-  胶条类型 EPDM软硬共挤胶条
-  隔热条 24宽
-  五金承重 最高170Kg
-  玻璃规格 6G+12A+6G / 5G+15A+5G 5G+9A+5G+9A+5G
-  扇宽度适用范围 /460mm-1200mm(内开) 扇高度适用范围 /800mm-2500mm(内开)
-  五金配件
内开：无底座执手+标准内开内倒配置+隐藏铰链
外开：方轴执手+标准外开窗配置+免铣槽摩擦铰链+防坠落装置

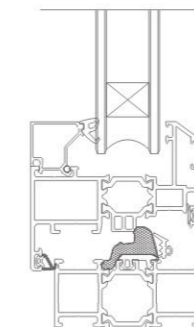
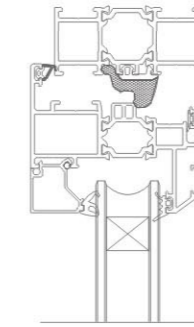

70内开窗

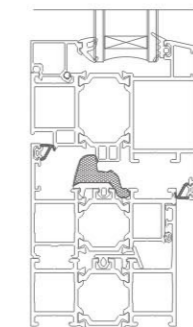

70外开窗

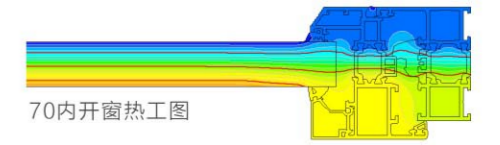

70内开窗热工图

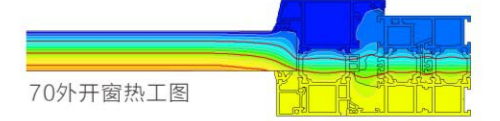

70外开窗热工图

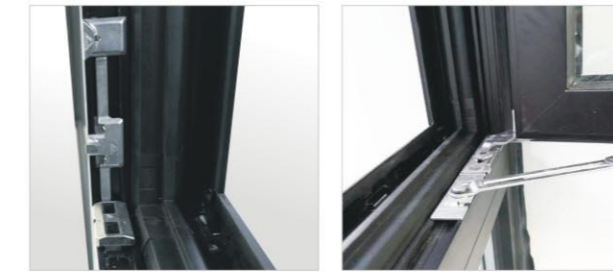

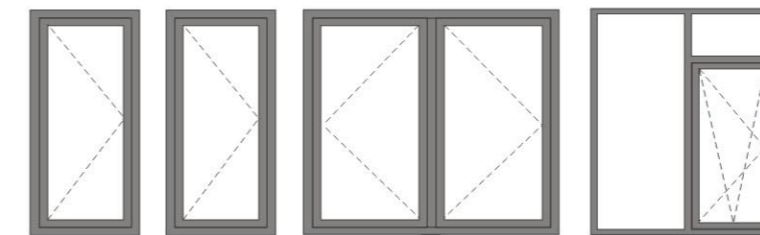

开合方式 / SWITCHING MODE



 保温性能 / Thermal insulation
W/(m²·K) : 1.75

 隔音性能 / Acoustic Performance
(dB) : 3级

 气密性能 / Air tightness
(m³/h) : 8级

 水密性能 / Water Tightness
(Pa) : 6级

 抗风压性能 / Wind Load Resistance
(kpa) : 9级

SIGHT 11

L70-ID / OD

INSIDE & OUTSIDE CASEMENT DOOR

内开 / 外开门

门型特点 / PRODUCT FEATURES

- 外框和内框之间采用等压、采用EPDM发泡胶条，使门密封性能和隔热性能更优越。
- 采用复合式三腔设计，刚性强，独立排水系统，使窗体排水顺畅，不会发生雨水倒灌的现象。
- 选用优质铝合金型材，先进表面处理工艺，整窗结构更牢固、更耐用，美观时尚。
- 合页安装于侧门，门框四周布置联动五金件，门厚实，安全性更好。

产品性能 / PERFORMANCE

-  型材壁厚
2.1mm
-  型材处理
消光电泳 / 喷涂等
-  胶条类型
EPDM软硬共挤胶条
-  隔热条
24宽
-  五金承重
最高180Kg
-  玻璃规格
6G+12A+6G / 5G+15A+5G
5G+9A+5G+9A+5G
-  扇宽度适用范围 / 700mm-1200mm
扇高度适用范围 / 2200mm-2800mm
-  五金配件
双面执手+多点锁闭机构+锁芯+标准欧式合页

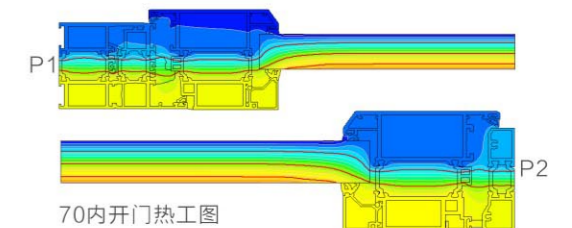
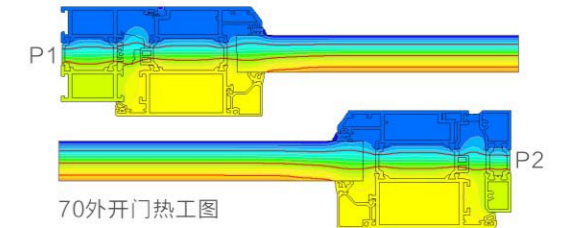

开合方式 / SWITCHING MODE

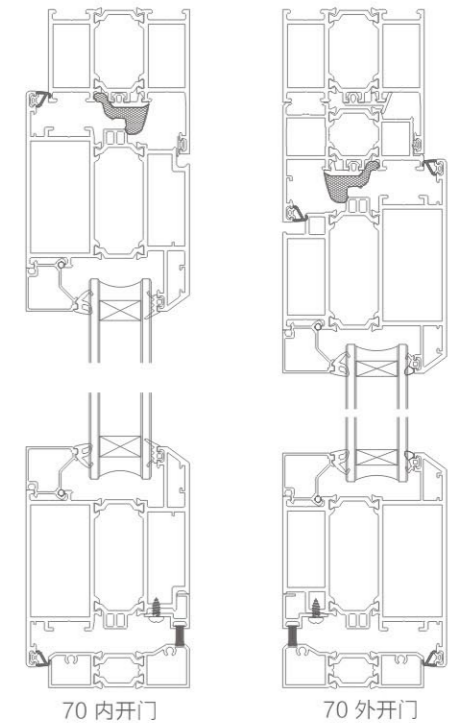
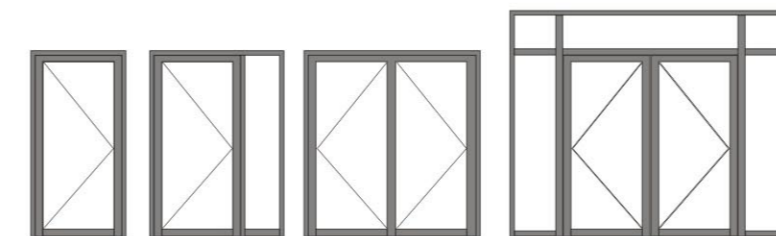

曜石黑



金属咖啡



金属灰



黑金沙

SIGHT 12



 保温性能 / Thermal insulation
W/(m²·K) : 1.8

 隔音性能 / Acoustic Performance
(dB) : 3级

 气密性能 / Air tightness
(m³/h) : 7级

 水密性能 / Water Tightness
(Pa) : 6级

 抗风压性能 / Wind Load Resistance
(kpa) : 9级

SIGHT 13

L80-IW / OW

INSIDE & OUTSIDE CASEMENT WINDOW

内开 / 外开窗

门型特点 / PRODUCT FEATURES

- 隔热断桥型材，保温节能；三腔结构，强度高、隔音好。型材设计采用欧洲标准五金槽口，多个锁点，达到更好的防盗作用。
- 采用进口粉末喷涂、进口消光漆、氟碳喷涂。
- 标配欧洲高端五金配件，轻松开闭，安全可靠。
- 外框和内扇之间等压、减压原理设计，采用欧标三元乙丙（EPDM）密封胶条，使隔音、隔热、防水、气密性能更佳。
- 中空超白钢化玻璃，也可选配内置手动磁控百叶、电动百叶。
- 内平开、内倒（可带纱网）外开。
- 别墅、自建别墅、高档小区、办公楼、酒店、豪华公寓等中高端消费群体。



曜石黑



金属咖啡



金属灰



黑金沙

SIGHT 14

产品性能 / PERFORMANCE



型材壁厚
1.8mm



型材处理
消光电泳 / 喷涂等



胶条类型
EPDM软硬共挤胶条



隔热条
35.3宽



五金承重
最高170Kg



玻璃规格
5G+20A+5G / 6G+18A+6G
8G+20A+8G / 5G+15A+5G+15A+5G



扇宽度适用范围 / 460mm-1200mm(内开)
扇高度适用范围 / 800mm-2500mm(内开)



五金配件
内开：无底座执手+标准内开内倒配置+隐藏铰链
外开：方轴执手+标准外开窗配置+免铣槽摩擦铰链+防坠落装置

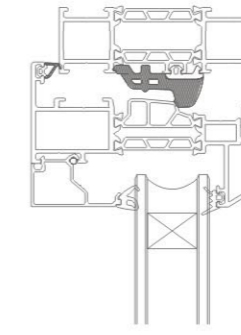

80 内开窗

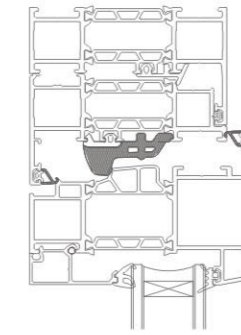

80 外开窗



开合方式 / SWITCHING MODE

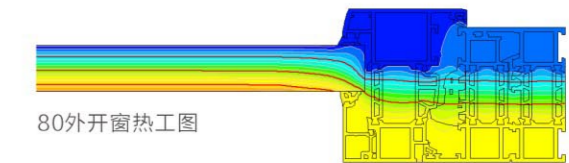
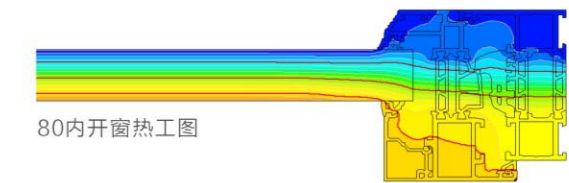
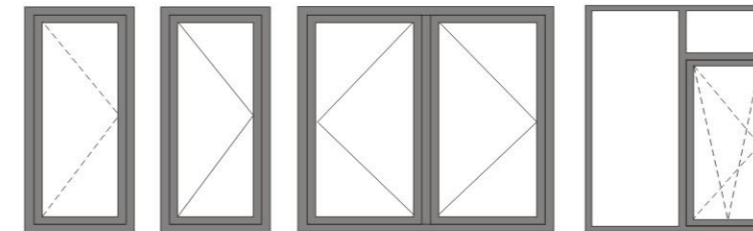

保温性能 / Thermal insulation
W/(m²·K) : 1.4

隔音性能 / Acoustic Performance
(dB) : 4级

气密性能 / Air tightness
(m³/h) : 8级

水密性能 / Water Tightness
(Pa) : 6级

抗风压性能 / Wind Load Resistance
(kpa) : 9级

SIGHT 15

L80-IW

INSIDE & OUTSIDE CASEMENT WINDOW

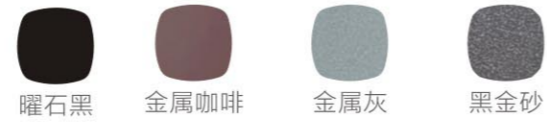

双内开窗

门型特点 / PRODUCT FEATURES

- 隔热断桥型材，保温节能；三腔结构，强度高、隔音好。型材设计采用欧洲标准五金槽口，多个锁点，达到更好的防盗作用。
- 采用进口粉末喷涂、进口消光漆、氟碳喷涂。
- 标配欧洲高端五金配件，轻松开闭，安全可靠。
- 外框和内扇之间等压、减压原理设计，采用欧标三元乙丙（EPDM）密封胶条，使隔音、隔热、防水、气密性能更佳。
- 中空超白钢化玻璃，也可选配内置手动磁控百叶。
- 内平开、内倒（自带可内开纱网）。
- 别墅、自建别墅、高档小区、办公楼、酒店、豪华公寓等中高端消费群体。



SIGHT 16

产品性能 / PERFORMANCE

- 型材壁厚 1.8mm
- 型材处理 消光电泳 / 喷涂等
- 胶条类型 EPDM软硬共挤胶条
- 隔热条 35.3宽
- 金刚纱网 防蚊、防虫，防盗
- 五金承重 最高170Kg
- 玻璃规格 5G+20A+5G / 6G+18A+6G
8G+20A+8G / 5G+15A+5G+15A+5G
- 扇宽度适用范围 / 460-1000mm(内开)
扇高度适用范围 / 800-2000mm(内开)
- 五金配件 无底座执手+标准内开内倒配置+隐藏铰链
隐藏纱窗启闭装置+标准纱窗合页+自吸装置

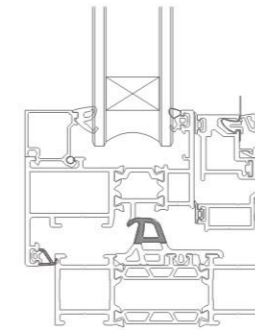
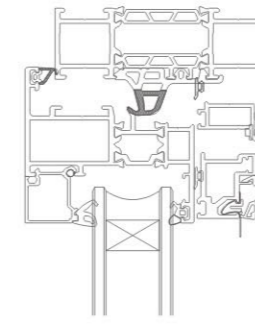

80 双内开窗

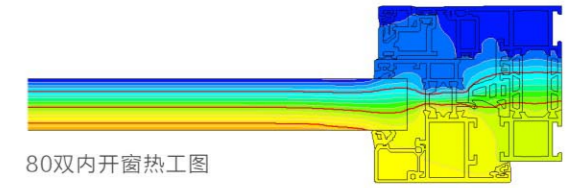

80双内开窗热工图

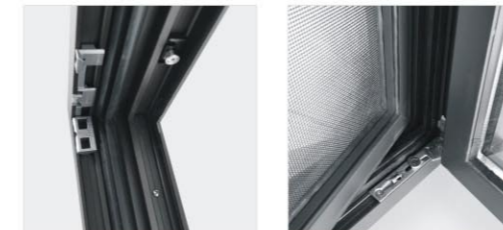

开合方式 / SWITCHING MODE

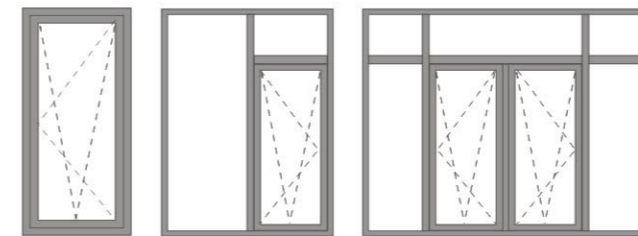

保温性能 / Thermal insulation
W/(m²·K) : 1.4

隔音性能 / Acoustic Performance
(dB) : 3级

气密性能 / Air tightness
(m³/h) : 7级

水密性能 / Water Tightness
(Pa) : 6级

抗风压性能 / Wind Load Resistance
(kpa) : 9级

SIGHT 17

L80-ID / OD

INSIDE & OUTSIDE CASEMENT DOOR

内开 / 外开门

门型特点 / PRODUCT FEATURES

- 外框和内框之间采用等压、采用EPDM发泡胶条，使门密封性能和隔热性能更优越。
- 采用复合式三腔设计，刚性强，独立排水系统，使窗体排水顺畅，不会发生雨水倒灌的现象。
- 选用优质铝合金型材，先进表面处理工艺，整窗结构更牢固、更耐用，美观时尚。
- 合页安装于侧门，门框四周布置联动五金件，门厚实，安全性更好。



曜石黑



金属咖啡



金属灰



黑金沙

SIGHT 18

产品性能 / PERFORMANCE

-  型材壁厚
2.1mm
-  型材处理
消光电泳 / 喷涂等
-  胶条类型
EPDM软硬共挤胶条
-  隔热条
35.3宽
-  五金承重
最高180Kg
-  玻璃规格
5G+20A+5G / 6G+18A+6G
8G+20A+8G / 5G+15A+5G+15A+5G
-  扇宽度适用范围 /700mm-1200mm
扇高度适用范围 /2200mm-2800mm
-  五金配件
双面执手+多点锁闭机构+锁芯+标准欧式合页

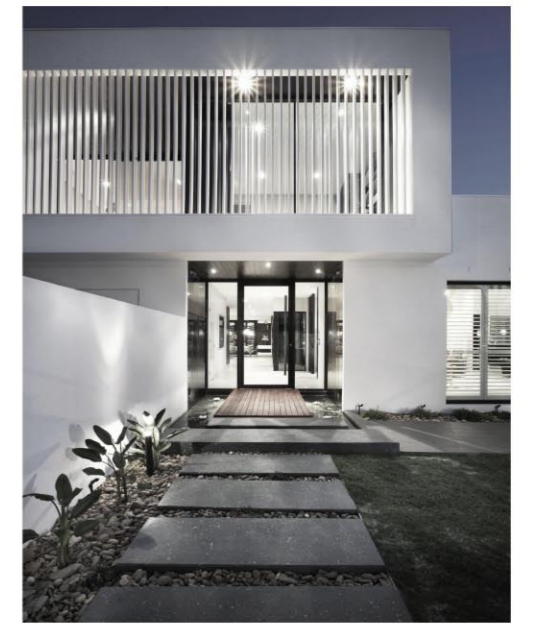
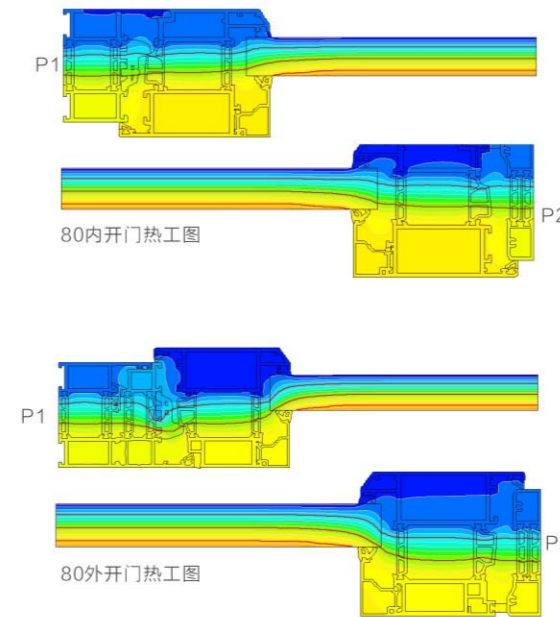

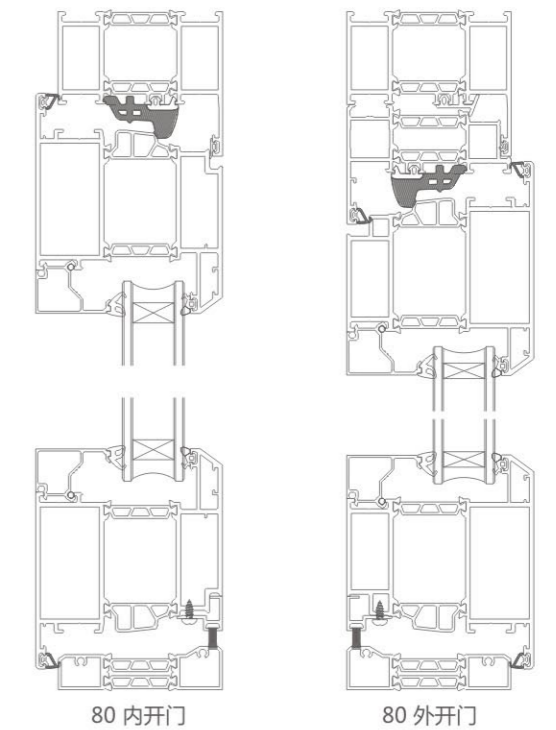
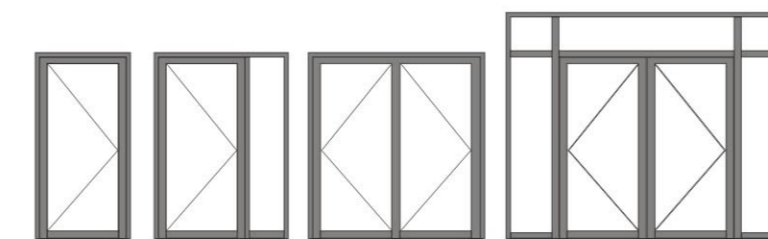

开合方式 / SWITCHING MODE



 保温性能 / Thermal insulation
W/(m²·K) : 1.4

 隔音性能 / Acoustic Performance
(dB) : 3级

 气密性能 / Air tightness
(m³/h) : 7级

 水密性能 / Water Tightness
(Pa) : 6级

 抗风压性能 / Wind Load Resistance
(kpa) : 9级

SIGHT 19

L90-OW

OUTSIDE CASEMENT WINDOW WITH HIDDEN YARN

外开·隐纱

外平开系统，折叠隐藏防蚊纱

隐纱外开窗

门型特点 / PRODUCT FEATURES

- 隔热断桥型材，保温节能；三腔结构，强度高、隔音好。型材设计采用欧洲标准五金槽口，多个锁点，达到更好的防盗作用。
- 采用进口粉末喷涂、进口消光漆、氟碳喷涂。
- 标配欧洲高端五金配件，轻松开闭，安全可靠。
- 外框和内扇之间等压、减压原理设计，采用欧标三元乙丙（EPDM）密封胶条，使隔音、隔热、防水、气密性能更佳。
- 中空超白钢化玻璃，也可选配内置手动磁控百叶。
- 外平开（自带折叠纱网）。
- 别墅、自建别墅、高档小区、办公楼、酒店、豪华公寓等中高端消费群体。



曜石黑



金属咖啡



金属灰



黑金沙

SIGHT 20

产品性能 / PERFORMANCE

- 型材壁厚 2.0mm
- 型材处理 消光电泳 / 喷涂 / 木纹等
- 胶条类型 EPDM软硬共挤胶条
- 隔热条 35.3宽
- 外挂高透纱网 防蚊、防虫，防盗
- 五金承重 最高80Kg
- 玻璃规格 5G+27A+5G / 6G+24A+6G / 8G+20A+8G / 5G+15A+5G+15A+5G
- 扇宽度适用范围 /450mm-800mm 扇高度适用范围 /800mm-1500mm
- 五金配件 方轴执手+标准外开窗配置+免铣槽摩擦铰链+防坠落装置

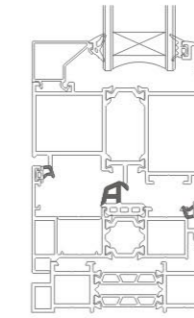
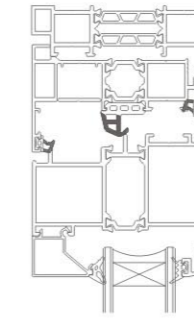

90 外开带隐纱窗

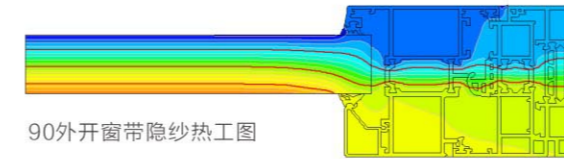

90外开窗带隐纱热工图

开合方式 / SWITCHING MODE

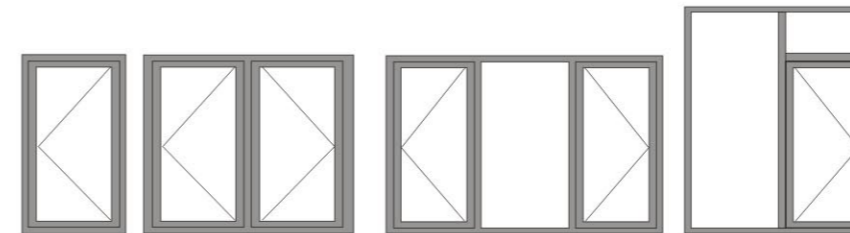

保温性能 / Thermal insulation
W/(m²·K) : 1.5

隔音性能 / Acoustic Performance
(dB) : 3级

气密性能 / Air tightness
(m³/h) : 8级

水密性能 / Water Tightness
(Pa) : 6级

抗风压性能 / Wind Load Resistance
(kpa) : 9级

SIGHT 21

116-OW

OUTSIDE CASEMENT WINDOW WITH HIDDEN YARN

外开窗纱一体窗 门型特点 / PRODUCT FEATURES

- 窗纱独立设计，可单独拆卸与安装，方便安装、拆洗和保护。
- 采用优质精钢纤维网，质量轻、强度高、坚固耐用、寿命长久。
- 采用复合式三腔设计，独特的排水工艺，有效提升整窗的水密性。
- 独特窗纱吻合设计，密封性能好，远离蚊虫干扰。



曜石黑



金属咖啡



金属灰



黑金沙

SIGHT 22

产品性能 / PERFORMANCE

-  型材壁厚 2.0mm
-  型材处理 消光电泳/喷涂等
-  胶条类型 EPDM软硬共挤胶条
-  隔热条 20宽
-  金刚纱网 防蚊、防虫、防盗
-  五金承重 最高170Kg
-  玻璃规格 5G+15A+5G
-  扇宽度适用范围 /450mm-1000mm
扇高度适用范围 /800mm-1600mm
-  五金配件 优质高端国产五金配件

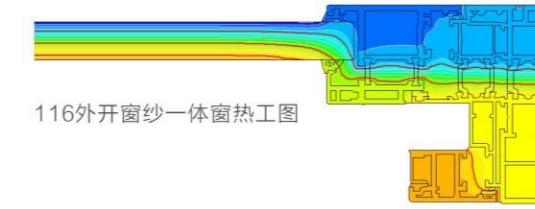

116外开窗纱一体窗热工图



开合方式 / SWITCHING MODE

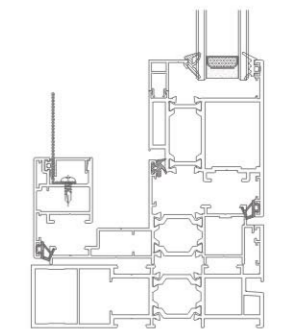
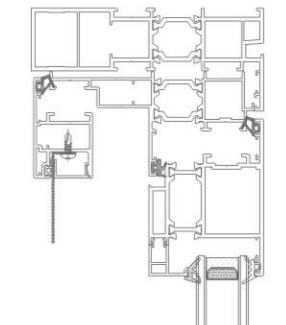
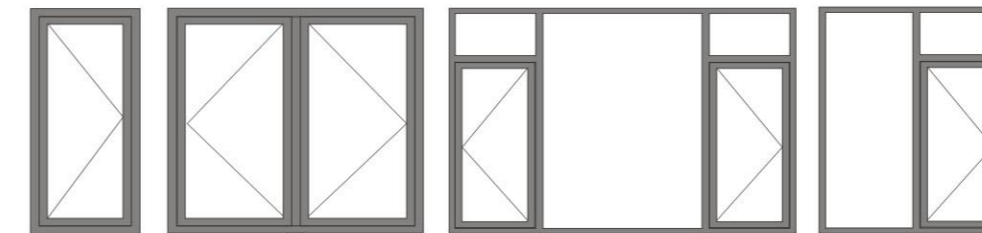

116 外开窗纱一体

 保温性能 / Thermal insulation
W/(m²·K) : 1.9

 隔音性能 / Acoustic Performance
(dB) : 3级

 气密性能 / Air tightness
(m³/h) : 7级

 水密性能 / Water Tightness
(Pa) : 6级

 抗风压性能 / Wind Load Resistance
(kpa) : 9级

SIGHT 23

L127-IW / OW

OPEN INSIDE / OUTSIDE

CASEMENT WINDOW

内/外开窗纱一体窗 门型特点 / PRODUCT FEATURES

- 窗纱独立设计，可单独拆卸与安装，方便安装、拆洗和保护。
- 采用优质精钢纤维网，质量轻、强度高、坚固耐用、寿命长久。
- 采用复合式三腔设计，独特的排水工艺，有效提升整窗的水密性。
- 独特窗纱吻合设计，密封性能好，远离蚊虫干扰。



曜石黑



金属咖啡



金属灰



黑金沙

SIGHT 24

产品性能 / PERFORMANCE

-  型材壁厚 1.8mm
-  型材处理 消光电泳 / 喷涂等
-  胶条类型 EPDM软硬共挤胶条
-  隔热条 24宽
-  金刚纱网 防蚊、防虫、防盗
-  五金承重 内开:最高170KG / 外开:最高90KG
-  玻璃规格 5G+15A+5G
-  扇宽度适用范围 /450mm-1000mm 扇高度适用范围 /800mm-1600mm
-  五金配件 内开: 无底座执手+标准内开配置+免铣槽摩擦铰链; 弯方轴执手+标准外开配置+隐藏铰链; 外开: 方轴执手+标准内开配置+免铣槽摩擦铰链; 弯方轴执手+标准外开配置+免铣槽摩擦铰链+防坠落装置;

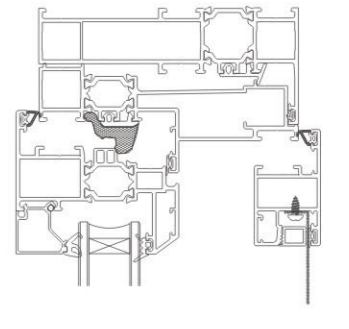
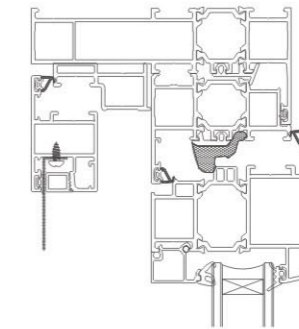
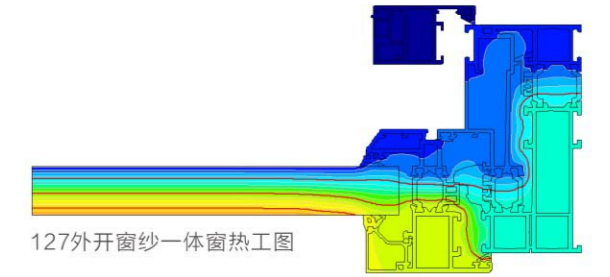
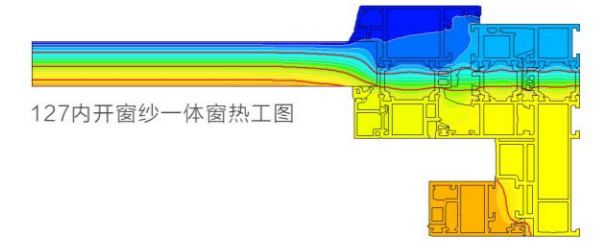

开合方式 / SWITCHING MODE

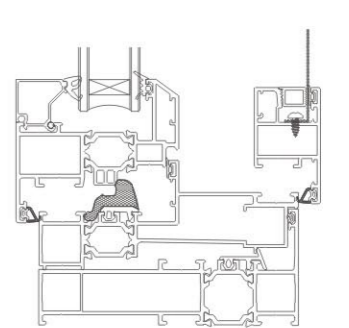
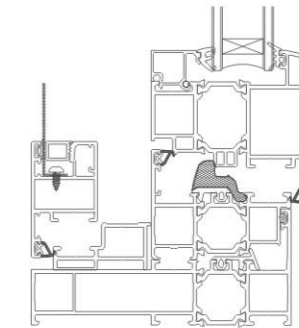
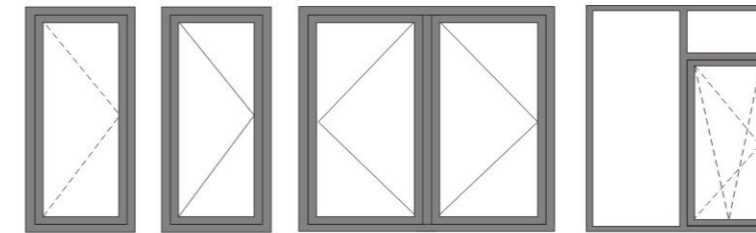



127 外开窗纱一体

127 内开窗纱一体

 保温性能 / Thermal insulation
W/(m²·K) : 1.8

 隔音性能 / Acoustic Performance
(dB): 3级

 气密性能 / Air tightness
(m³/h) : 7级

 水密性能 / Water Tightness
(Pa) : 6级

 抗风压性能 / Wind Load Resistance
(kpa) : 9级

SIGHT 25

L136-LD

DOUBLE TRACK LIFTING SLIDING DOOR

双轨提升推拉门

门型特点 / PRODUCT FEATURES

- 开启灵活，而且经久耐用，具有优越的保温性能，节能效果显著。
- 框体强度高，坚固耐用，抗风压强，不变形，比较适合高层建筑和民用住宅。
- 密封性强而且防水隔音还有隔音性能好，美观舒适，坚固耐用。
- 不锈钢导轨，可做单轨，双轨。
- 门框导向槽分体结构，有效防止门户撬开，搭配多锁点设计，防盗性能大大增强
- 先进表面处理工艺，整体门结构更牢固，更耐用，美观大方。

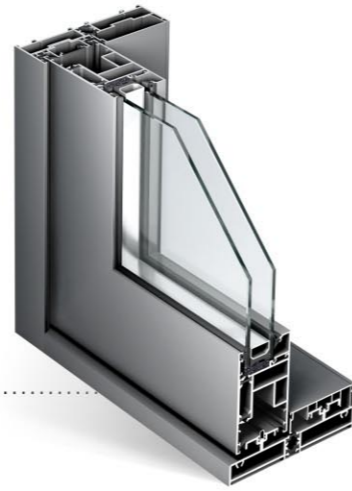

产品性能 / PERFORMANCE

- 型材壁厚 2.1mm
- 型材处理 消光电泳 / 喷涂等
- 胶条类型 EPDM软硬共挤胶条
- 隔热条 14.8宽
- 五金承重 最高400Kg
- 玻璃规格 5G+15A+5G
- 扇宽度适用范围 / 500mm-2500mm
扇高度适用范围 / 2200mm-2800mm
- 五金配件 双面执手+标准300KG承重提升套件+锁芯

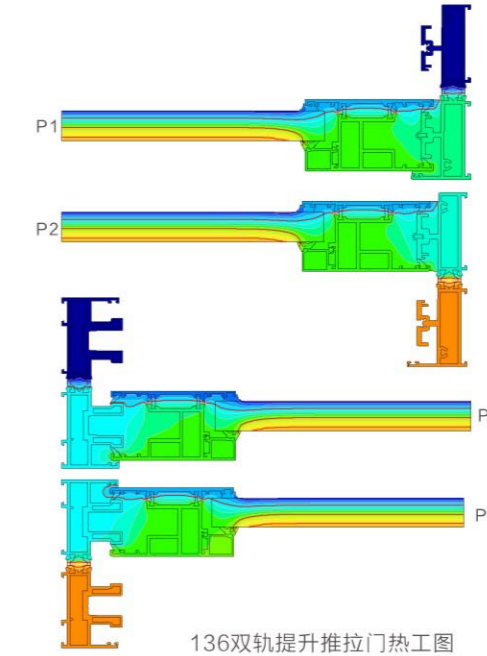

曜石黑



金属咖啡



金属灰

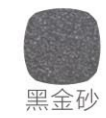

黑金沙

SIGHT 26

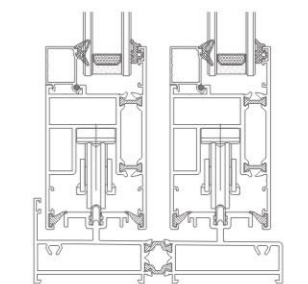
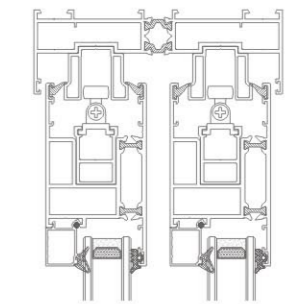
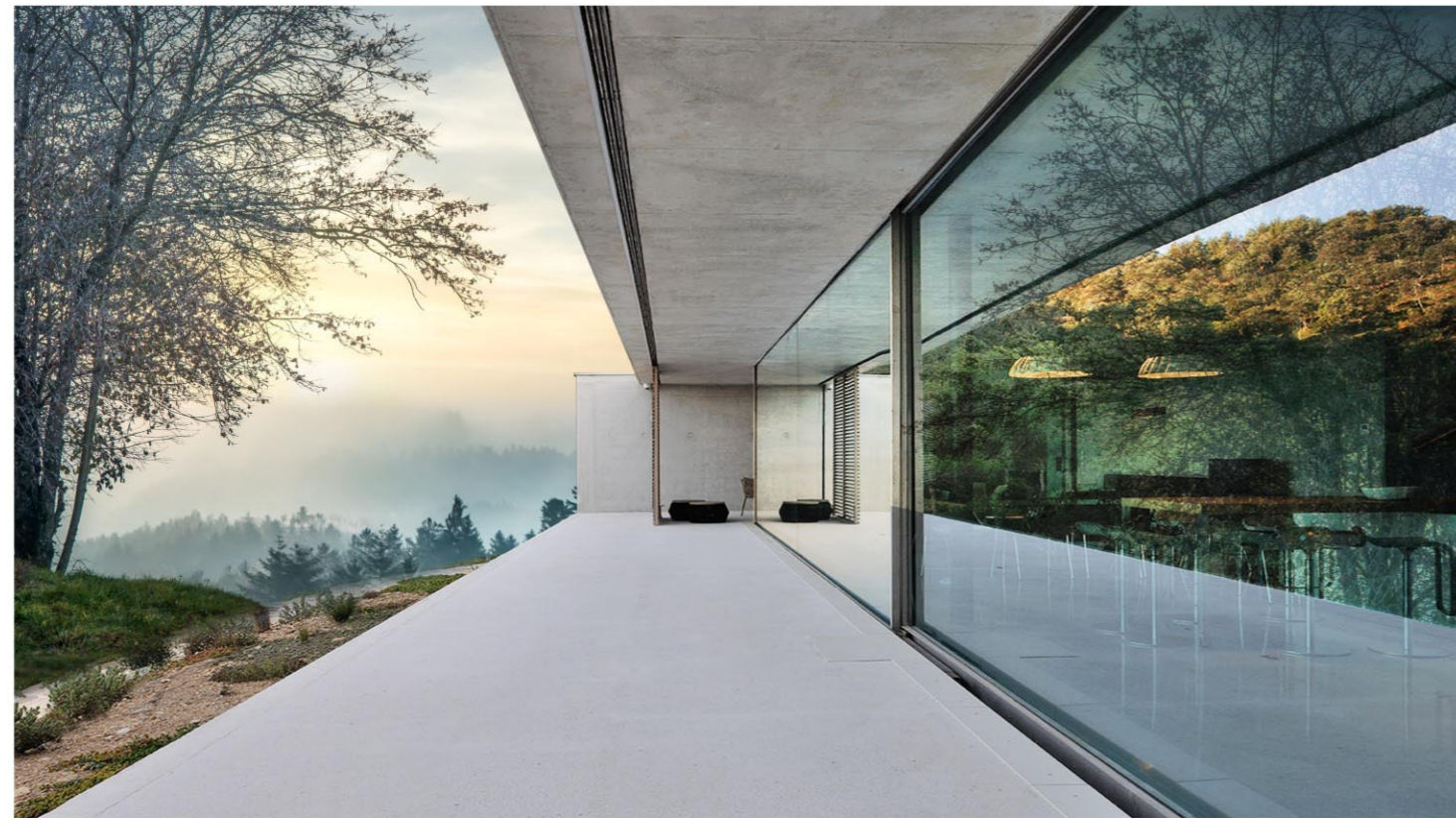

136 推拉门

开合方式 / SWITCHING MODE



保温性能 / Thermal insulation
W/(m²·K) : 2.25

隔音性能 / Acoustic Performance
(dB) : 3级

气密性能 / Air tightness
(m³/h) : 7级

水密性能 / Water Tightness
(Pa) : 4级

抗风压性能 / Wind Load Resistance
(kpa) : 7级

SIGHT 27

L204 -LD

THREE RAIL LIFTING SLIDING DOOR

三轨提升推拉门 (带金刚网)

门型特点 / PRODUCT FEATURES

- 采用欧标设计，有效提升的隔音效果及房屋整体保温性能，阻止室内室外热能传递，节能、环保、舒适。
- 超强抗风压设计，能将门扇牢牢锁住，即使在东部沿海等台风多发地区也能安心使用。
- 复合式三腔设计，刚性强，独立排水系统，使窗体排水顺畅，不会发生雨水倒灌的现象。
- 不锈钢导轨，可做三轨、三轨带金刚网。
- 门框导向槽分体结构，有效防止门户撬开，搭配多锁点设计，防盗性能大大增强。
- 选用优质铝合金型材，先进表面处理工艺，整门结构更牢固、更耐用，美观时尚。



曜石黑



金属咖啡



金属灰



黑金沙

SIGHT 28

产品性能 / PERFORMANCE

- 型材壁厚 2.1mm
- 型材处理 消光电泳 / 喷涂 / 木纹等
- 胶条类型 EPDM软硬共挤胶条
- 隔热条 14.8宽
- 金刚纱网 防蚊、防虫，防盗
- 五金承重 最高400Kg
- 玻璃规格 5G+15A+5G
- 扇宽度适用范围 /500mm-2500mm
扇高度适用范围 /2200mm-2800mm
- 五金配件 双面执手+标准300KG承重提升套件+锁芯；

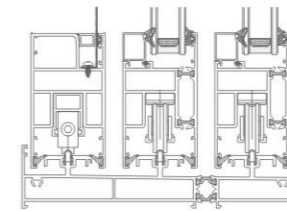
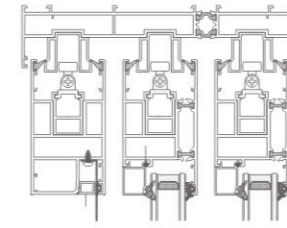

204 推拉门

开合方式 / SWITCHING MODE

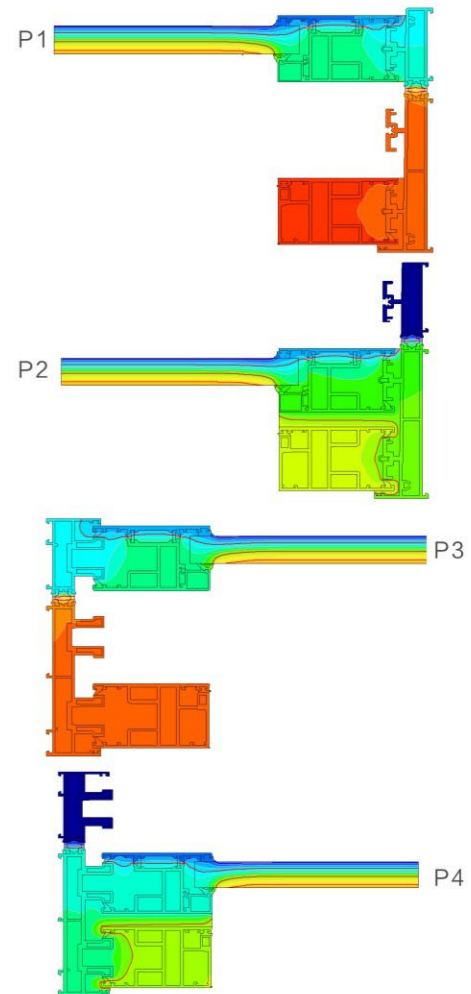
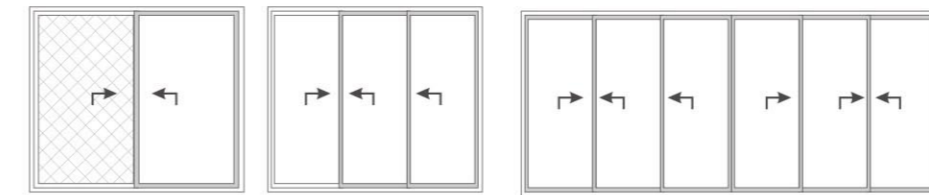

204三轨提升推拉门(带金刚网)热工图

保温性能 / Thermal insulation
W/(m²·K) : 2.25

隔音性能 / Acoustic Performance
(dB) : 3级

气密性能 / Air tightness
(m³/h) : 7级

水密性能 / Water Tightness
(Pa) : 4级

抗风压性能 / Wind Load Resistance
(kpa) : 7级

SIGHT 29

L120 -NSD

MEDIUM NARROW SLIDING DOOR

中窄推拉门

门型特点 / PRODUCT FEATURES

- 该中窄系列采用国际流行的简约设计理念，极简的风格进一步贴近年轻一代的审美需求。
- 装在室内使得空间视野宽敞，减少压抑感，装在阳台使得客厅更加通透明亮，室内外景观融为一体更加和谐。
- 上滑配备定滑轮，推拉顺畅静音不晃动，下滑配备不锈钢轨道，永不脱色，减少推拉摩擦阻力，使得门扇操作轻盈顺畅无噪音。
- 防撞密封：门扇配置有防撞密封胶条，起到防撞静音密封作用，配合多道毛条密封使得此推拉门拥有良好的密闭性能。先进表面处理工艺，整体门窗结构更牢固、耐用。。



曜石黑



金属咖啡



金属灰



黑金沙

SIGHT 30

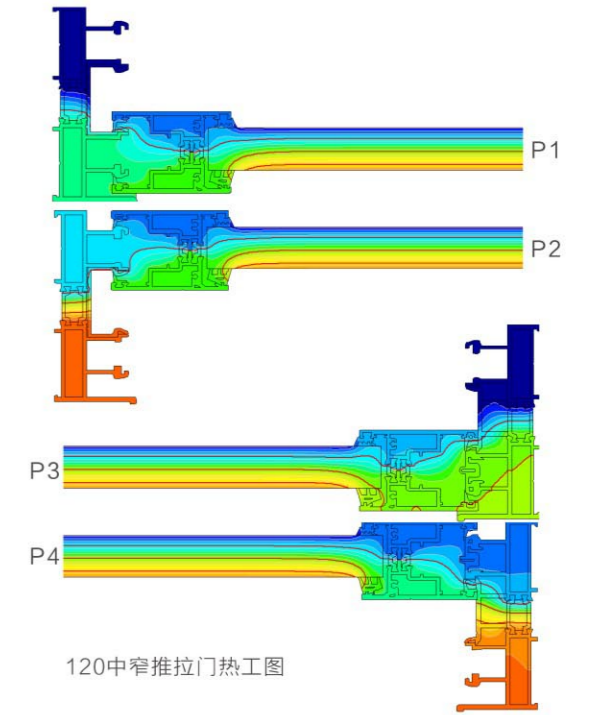

产品性能 / PERFORMANCE

- 型材壁厚 2.3mm
- 型材处理 消光电泳 / 喷涂 等
- 胶条类型 EPDM软硬共挤胶条
- 隔热条 14.8宽
- 五金承重 最高250Kg
- 玻璃规格 5G+20A+5G
- 扇宽度适用范围 /500mm-2500mm
扇高度适用范围 /2200mm-2800mm
- 五金配件 双面执手+标准150KG承重提升套件+锁芯；

中窄·极简

窄边框时代，MAX大平层视觉

开合方式 / SWITCHING MODE

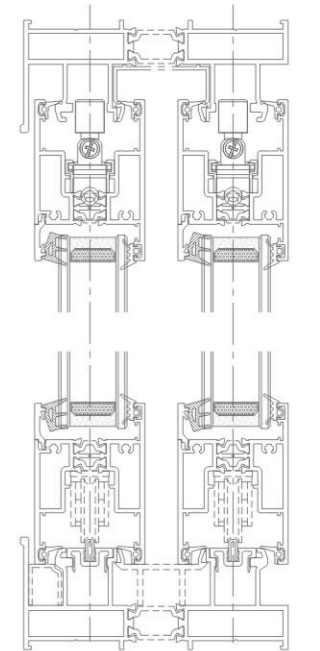
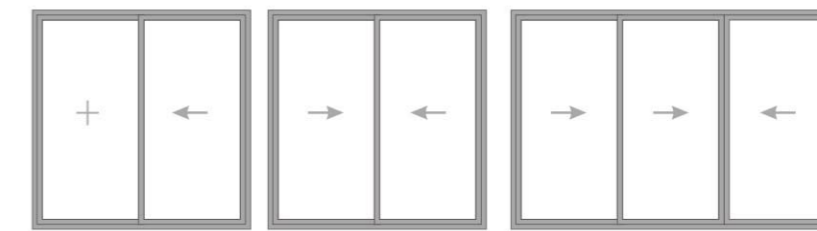

120 中窄推拉门

保温性能 / Thermal insulation
W/(m²·K) : 2.25

隔音性能 / Acoustic Performance
(dB) : 3级

气密性能 / Air tightness
(m³/h) : 7级

水密性能 / Water Tightness
(Pa) : 4级

抗风压性能 / Wind Load Resistance
(kpa) : 7级

SIGHT 31

L185-NSD

MEDIUM NARROW SLIDING DOOR

中窄推拉门

门型特点 / PRODUCT FEATURES

- 该中窄系列采用国际流行的简约设计理念，极简的风格进一步贴近年轻一代的审美需求。
- 有着大视野，大玻璃阳光充裕、风格简约时尚。
- 极简风格的阐释，剔除一切多余的装饰，以简单到精致为追求，回归自然。
- 可以表现为极简造型、极简设计、极简配置，极富线条感，开启灵活，也具有优越的保温性能、节能性能。
- 装在室内使得空间视野宽敞，减少压抑感，装在阳台使得客厅更加通透明亮，室内外景观融为一体更加和谐。



曜石黑



金属咖啡



金属灰

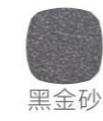

黑金沙

产品性能 / PERFORMANCE

- | | | |
|--------------------|---|---------------|
| 型材处理
消光电泳 / 喷涂等 | 五金承重
最高250Kg | 型材壁厚
2.3mm |
| 胶条类型
EPDM软硬共挤胶条 | 玻璃规格
5G+20A+5G | |
| 隔热条
14.8宽 | 扇宽度适用范围 /500mm-2500mm
扇高度适用范围 /2200mm-2800mm | |
| 金刚纱网
防蚊、防虫，防盗 | 五金配件
双面执手+标准150KG承重提升套件+锁芯； | |

开合方式 / SWITCHING MODE

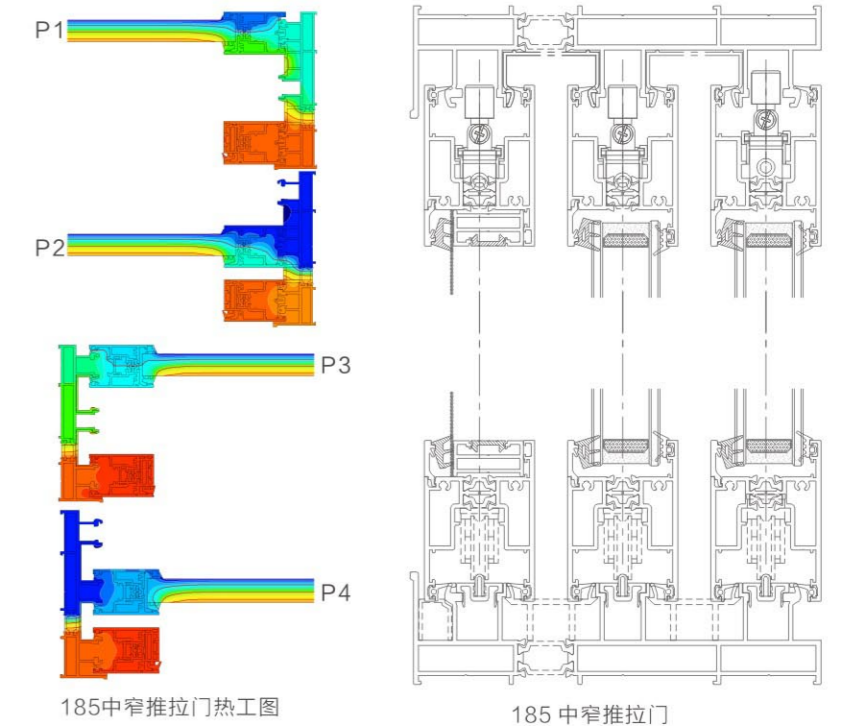
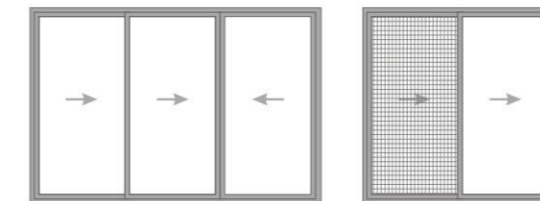

- | | | | | |
|---|--|--|-------------------------------------|--|
| 保温性能 / Thermal insulation
W/(m ² ·K) : 2.25 | 隔音性能 / Acoustic Performance
(dB) : 3级 | 气密性能 / Air tightness
(m ³ /h) : 7级 | 水密性能 / Water Tightness
(Pa) : 4级 | 抗风压性能 / Wind Load Resistance
(kpa) : 7级 |
|---|--|--|-------------------------------------|--|

DOUBLE RAIL TRACK SLIDING WINDOW

双轨推拉窗

产品性能 / PERFORMANCE

-  型材壁厚 1.6mm
-  型材处理 消光电泳 / 喷涂 等
-  胶条类型 优质毛条
-  隔热条 14.8宽
-  五金承重 最高70Kg
-  玻璃规格 5G+12A+5G
-  扇宽度适用范围 /350mm-1500mm
扇高度适用范围 /1000mm-1500mm
-  五金配件 碰钩锁+高承重双滑轮



THREE RAIL TRACK SLIDING WINDOW

三轨推拉窗 (金刚网)

产品性能 / PERFORMANCE

-  型材壁厚 1.6mm
-  型材处理 消光电泳 / 喷涂 等
-  胶条类型 优质毛条
-  隔热条 14.8宽
-  金刚纱网 防蚊、防虫、防盗
-  五金承重 最高70Kg
-  玻璃规格 5G+12A+5G
-  扇宽度适用范围 /350mm-1500mm
扇高度适用范围 /1000mm-1500mm
-  五金配件 碰钩锁+高承重双滑轮、金刚网纱窗

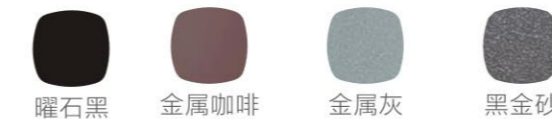







-  保温性能 /Thermal insulation W/(m²·K) : 2.25
-  隔音性能/Acoustic Performance (dB): 3级
-  气密性能/Air tightness (m³/h) : 7级
-  水密性能/Water Tightness (Pa) : 4级
-  抗风压性能/Wind Load Resistance (kpa) : 7级

-  保温性能 /Thermal insulation W/(m²·K) : 2.25
-  隔音性能/Acoustic Performance (dB): 3级
-  气密性能/Air tightness (m³/h) : 7级
-  水密性能/Water Tightness (Pa) : 4级
-  抗风压性能/Wind Load Resistance (kpa) : 7级

EXTERNAL HANGING HIGH POROSITY/BUDDHA'S WARRIOR ATTENDANT TSCREEN WINDOW

外挂高透网 / 外挂金刚网

产品性能 / PERFORMANCE

-  型材处理
消光电泳 / 喷涂 / 木纹等
-  型材壁厚
1.4mm
-  胶条类型
EPDM软硬共挤胶条
-  外挂高透网 / 外挂金刚纱网
防蚊、防虫, 防盗
-  五金承重
最高50Kg
-  扇宽度适用范围 /350mm-800mm
扇高度适用范围 /600mm-1500mm
-  五金配件
隐藏纱窗启闭装置+标准纱窗合页+自吸装置



U-SHAPED HOLLOW / SOLID GLASS GUARDRAIL U型空心 / 实心款护栏

产品性能 / PERFORMANCE

-  型材处理
拉丝银白
-  型材壁厚
10mm
-  胶条类型
EPDM胶条
-  玻璃规格
6G+1.14PVB+6G



GLASS GUARDRAIL 开启扇玻璃护栏

产品性能 / PERFORMANCE

-  型材处理
消光电泳 / 喷涂
-  玻璃规格
5G+0.76PVB+5G



SOLID GLASS GUARDRAIL 实心重款玻璃护栏

产品性能 / PERFORMANCE

-  型材处理
拉丝银白
-  胶条类型
EPDM胶条
-  玻璃规格
10G+1.52PVB+10G

